

Serie Series	Systemnummer System number	Bezeichnung	Designation	Abmessungen Dimensions	Seite Page
GCW 050, GCW 060	720001	Glashaltedichtung	Glass support gasket	-	2
GCW 050, GCW 060	720002	Dichtscheibe	Sealing disc	-	2
GCW 050, GCW 060	720005	Dehnungsdichtung	Expansion gasket	21 mm	2
GCW 050, GCW 060	720006	Bürstendichtung	Brush seal	8 mm	2
GCW 050, GCW 060	750004	Verglasungsdichtung	Glazing gasket	4 mm	2
GCW 050, GCW 060	750006	Verglasungsdichtung	Glazing gasket	6 mm	2
GCW 050, GCW 060	750007	Verglasungsdichtung außen	Glazing gasket outside	6 mm	3
GCW 050, GCW 060	750010	Silikon - Fugendichtung	Silicone gap gasket	-	3
GCW 050, GCW 060	750011	Fugendichtung	Gap gasket	-	3
GCW 050	750024	Druckleistendichtteil 4 mm	Pressure strip sealing part 4 mm	4 mm	3
GCW 050	750026	Druckleistendichtteil 6 mm	Pressure strip sealing part 6 mm	6 mm	3
GCW 050, GCW 060	750030	Dehnungsstoßstück	Expansion joint part	-	3
GCW 050, GCW 060	750031	Dehnungsdichtung	Expansion gasket	2 - 2,5 mm	4
GCW 050, GCW 060	750033	Dichtschnur	Sealing cord	4 mm	4
GCW 050	750035	Dichtstück	Sealing piece	-	4
GCW 050, GCW 060	750038	Dehnungsdichtung	Expansion gasket	-	4
GCW 050	750046	Dichtset T-Stoß-S	Sealing set T-Joint-S	-	4
GCW 050, GCW 060	750102	Verglasungsdichtung	Glazing gasket	2 mm	4
GCW 050, GCW 060	750203	Verglasungsdichtung innen	Glazing gasket inside	3 mm	5
GCW 050, GCW 060	750205	Verglasungsdichtung	Glazing gasket	5 mm	5
GCW 050, GCW 060	750207	Verglasungsdichtung	Glazing gasket	7 mm	5
GCW 050, GCW 060	750209	Verglasungsdichtung	Glazing gasket	9 mm	5
GCW 050, GCW 060	750211	Verglasungsdichtung	Glazing gasket	11 mm	5
GCW 050, GCW 060	750301	Verglasungsdichtung Außenecke	Glazing gasket outer corner	-	5
GCW 050, GCW 060	750311	Verglasungsdichtung Außenecke	Glazing gasket outer corner	-	6
GCW 050, GCW 060	750331	Verglasungsdichtung Innenecke	Glazing gasket inner corner	-	6
GCW 050, GCW 060	750402	Verglasungsdichtung außen	Glazing gasket outside	2 mm	6
GCW 050, GCW 060	760006	Verglasungsdichtung	Glazing gasket	6 mm	6
GCW 060	760024	Druckleistendichtteil 4 mm	Pressure strip sealing part 4 mm	4 mm	6
GCW 060	760026	Druckleistendichtteil 6 mm	Pressure strip sealing part 6 mm	6 mm	7
GCW 050, GCW 060	760030	Dehnungsstoßstück	Expansion joint part	-	7
GCW 060	760035	Dichtstück	Sealing piece	-	7
GCW 060	760046	Dichtset T-Stoß-S	Sealing set T-Joint-S	-	7
GCW 050, GCW 060	760104	Verglasungsdichtung	Glazing gasket	4 mm	7
GCW 050, GCW 060	760104 99	Verglasungsdichtung Rahmen	Glazing gasket frame	4 mm	8
GCW 050, GCW 060	760106	Verglasungsdichtung	Glazing gasket	6 mm	8
GCW 050, GCW 060	760106 99	Verglasungsdichtung Rahmen	Glazing gasket frame	6 mm	8
GCW 050, GCW 060	760108	Verglasungsdichtung	Glazing gasket	8 mm	8
GCW 050, GCW 060	760108 99	Verglasungsdichtung Rahmen	Glazing gasket frame	8 mm	8
GCW 050, GCW 060	760110	Verglasungsdichtung	Glazing gasket	10 mm	8
GCW 050, GCW 060	760110 99	Verglasungsdichtung Rahmen	Glazing gasket frame	10 mm	9
GCW 050, GCW 060	760112	Verglasungsdichtung	Glazing gasket	12 mm	9
GCW 050, GCW 060	760112 99	Verglasungsdichtung Rahmen	Glazing gasket frame	12 mm	9
GCW 050, GCW 060	760114	Verglasungsdichtung	Glazing gasket	14 mm	9
GCW 050, GCW 060	760114 99	Verglasungsdichtung Rahmen	Glazing gasket frame	14 mm	9
GCW 050, GCW 060	760116	Verglasungsdichtung	Glazing gasket	16 mm	9
GCW 050, GCW 060	760116 99	Verglasungsdichtung Rahmen	Glazing gasket frame	16 mm	10
GCW 050, GCW 060	770009	Verglasungsdichtung außen	Glazing gasket outside	1,5 mm	10
GCW 050, GCW 060	770010	Verglasungsdichtung außen	Glazing gasket outside	3,5 mm	10
GCW 050, GCW 060	760104 99	Bestellformular Dichtungsrahmen	Order form gasket frame	4 mm	11
GCW 050, GCW 060	760106 99	Bestellformular Dichtungsrahmen	Order form gasket frame	6 mm	12
GCW 050, GCW 060	760108 99	Bestellformular Dichtungsrahmen	Order form gasket frame	8 mm	13
GCW 050, GCW 060	760110 99	Bestellformular Dichtungsrahmen	Order form gasket frame	10 mm	14
GCW 050, GCW 060	760112 99	Bestellformular Dichtungsrahmen	Order form gasket frame	12 mm	15
GCW 050, GCW 060	760114 99	Bestellformular Dichtungsrahmen	Order form gasket frame	14 mm	16
GCW 050, GCW 060	760116 99	Bestellformular Dichtungsrahmen	Order form gasket frame	16 mm	17

Symbolerklärung | Pictogram declaration

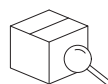

Farbe
Colour



Inhalt Verkaufseinheit
Unit of Sale



DIN - Richtung
DIN - direction



Verpackungseinheit
Per Unit

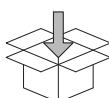

Mengeneinheit
Unit of Quantity







Produktkennzeichen
Product identifier 720001

Produktbezeichnung
Product designation Glashaltdichtung
Glass gasket

Artikelnummer
Item number ZB720001

Für Halterung Semi-SG und SG-Fassade

For fastener Semi-SG and SG curtain wall

Werkstoff Material						Best.Nr. (EAN) Order No. (EAN)
Silikon Silicone	schwarz black		50 m	1 ME	Karton carton	4021036920083

Passend zu Serie | Compatible to series

GCW 050
GCW 060





Produktkennzeichen
Product identifier 720006

Produktbezeichnung
Product designation Bürstendichtung
Brush seal

Artikelnummer
Item number E006577

Verbindung von Dehnprofilen

Connection of expansion profiles

Werkstoff Material						Best.Nr. (EAN) Order No. (EAN)
EPDM EPDM	schwarz black		100 m	1 ME	Karton carton	4021036897088

Passend zu Serie | Compatible to series

GCW 050
GCW 060

Produktkennzeichen
Product identifier 720002

Produktbezeichnung
Product designation Dichtscheibe
Sealing disc

Artikelnummer
Item number ZB720002

Ø = 11 mm und Stärke 2 mm, Schraubabdeckung für Profil 159313

Ø = 11 mm and thickness 2 mm, screw cover for profile 159313

Werkstoff Material						Best.Nr. (EAN) Order No. (EAN)
Silikon Silicone	schwarz black		100 Stück piece	1 ME	Beutel bag	4021036920106

Passend zu Serie | Compatible to series

GCW 050
GCW 060

Produktkennzeichen
Product identifier 750004

Produktbezeichnung
Product designation Verglasungsdichtung außen
Outer glazing gasket

Artikelnummer
Item number ZB750004

Für gerade Druckleiste, Spaltbreite c = 4 mm.

For straight pressure strip, gap width c = 4 mm

Werkstoff Material						Best.Nr. (EAN) Order No. (EAN)
EPDM EPDM	schwarz black		100 m	1 ME	Karton carton	4021036529200

Passend zu Serie | Compatible to series

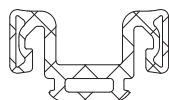
GCW 050
GCW 060





Produktkennzeichen
Product identifier 720005

Produktbezeichnung
Product designation Dehnungsdichtung
Expansion gasket

Artikelnummer
Item number E006323

Verbindung von Dehnprofilen

Connection of expansion profiles

Werkstoff Material						Best.Nr. (EAN) Order No. (EAN)
EPDM EPDM	schwarz black		100 m	1 ME	Karton carton	4021036734840

Passend zu Serie | Compatible to series

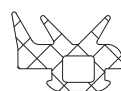
GCW 050
GCW 060





Produktkennzeichen
Product identifier 750006

Produktbezeichnung
Product designation Verglasungsdichtung außen
Outer glazing gasket

Artikelnummer
Item number ZB750006

Für gerade Druckleiste, Spaltbreite c = 6 mm.

For straight pressure strip, gap width c = 6 mm

Werkstoff Material						Best.Nr. (EAN) Order No. (EAN)
EPDM EPDM	schwarz black		100 m	1 ME	Karton carton	4021036529248

Passend zu Serie | Compatible to series

GCW 050
GCW 060

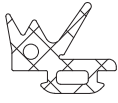

Produktkennzeichen
Product identifier **750007**

Produktbezeichnung
Product designation **Verglasungsdichtung außen**
Glazing gasket outside variable

Artikelnummer
Item number **ZB750007**

Variable Verglasungsdichtung außen für Polygonfassade, Einsatzbereich 0 - 10°, Spaltbreite c = 6 mm
Variable glazing gasket outside for polygonal curtain wall, application range 0 - 10°, gap width c = 6 mm

Werkstoff Material						Best.Nr. (EAN) Order No. (EAN)
EPDM EPDM	schwarz black		100 m	1 ME	Karton carton	4021036920182

Passend zu Serie | Compatible to series
GCW 050
GCW 060

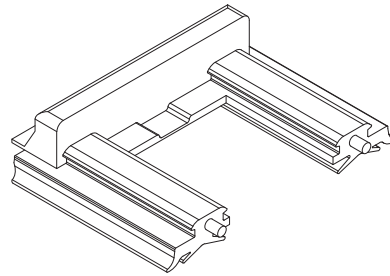

Produktkennzeichen
Product identifier **750024**

Produktbezeichnung
Product designation **Druckleistendichtteil 4 mm**
Pressure strip sealing part 4 mm

Artikelnummer
Item number **750024**

Anschlussformteil für Druckleiste 159310 und Dichtung 750004, Spaltbreite c = 4 mm
Molded connection part for pressure strip 159310 and gasket 750004, gap width c = 4 mm

Werkstoff Material						Best.Nr. (EAN) Order No. (EAN)
Silikon Silicone	schwarz black		20 Stück piece	1 ME	Beutel bag	4021036529231

Passend zu Serie | Compatible to series
GCW 050

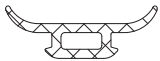

Produktkennzeichen
Product identifier **750010**

Produktbezeichnung
Product designation **Silikon - Fugendichtung**
Silicone gap gasket

Artikelnummer
Item number **ZB750010**

Äußere Dichtung für Ganz-Glas Fassade
Outer gasket for full glass curtain wall

Werkstoff Material						Best.Nr. (EAN) Order No. (EAN)
Silikon Silicone	schwarz black		50 m	1 ME	Karton carton	4021036920250

Passend zu Serie | Compatible to series
GCW 050
GCW 060

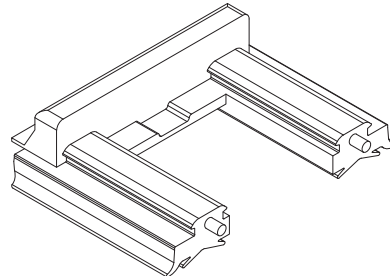

Produktkennzeichen
Product identifier **750026**

Produktbezeichnung
Product designation **Druckleistendichtteil 6 mm**
Pressure strip sealing part 6 mm

Artikelnummer
Item number **ZB750026**

Anschlussformteil für Druckleiste 159310 und Dichtung 750006, Spaltbreite c = 6 mm
Molded connection part for pressure strip 159310 and gasket 750006, gap width c = 6 mm

Werkstoff Material						Best.Nr. (EAN) Order No. (EAN)
Silikon Silicone	schwarz black		20 Stück piece	1 ME	Beutel bag	4021036529255

Passend zu Serie | Compatible to series
GCW 050



Produktkennzeichen
Product identifier **750011**

Produktbezeichnung
Product designation **Fugendichtung**
Gap gasket

Artikelnummer
Item number **ZB750011**

Deckt die Schraubenköpfe in der Druckleiste 159311 ab
Covers the screw heads in pressure strip 159311

Werkstoff Material						Best.Nr. (EAN) Order No. (EAN)
Silikon Silicone	schwarz black		100 m	1 ME	Karton carton	4021036920267

Passend zu Serie | Compatible to series
GCW 050
GCW 060

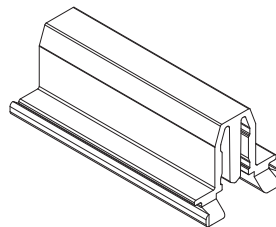

Produktkennzeichen
Product identifier **750030**

Produktbezeichnung
Product designation **Dehnungsstoßstück**
Expansion joint part

Artikelnummer
Item number **E-006175**

Einsatz in Pfosten bei Dehnungsstößen
Application in mullions at expansion joints

Werkstoff Material						Best.Nr. (EAN) Order No. (EAN)
EPDM EPDM	schwarz black		10 Stück piece	1 ME	Beutel bag	4021036181019

Passend zu Serie | Compatible to series
GCW 050



Produktkennzeichen
Product identifier **750031**

Produktbezeichnung
Product designation **Dehnungsdichtung**
Expansion gasket

Artikelnummer
Item number **ZB750031**

Verbindung von Dehnprofilen mit Blecheinlage, Blechdicke: 2 - 2,5 mm
Connection of expansion profiles with metal sheet inserts, sheet thickness: 2 - 2,5 mm

Werkstoff Material						Best.Nr. (EAN) Order No. (EAN)
EPDM EPDM	schwarz black		100 m	1 ME	Karton carton	4021036920342

Passend zu Serie | Compatible to series
GCW 050
GCW 060

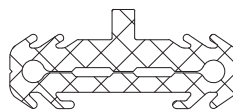

Produktkennzeichen
Product identifier **750038**

Produktbezeichnung
Product designation **Dehnungsdichtung**
Expansion gasket

Artikelnummer
Item number **ZB750038**

Verbindung von Dehnprofilen
Connection of expansion profiles

Werkstoff Material						Best.Nr. (EAN) Order No. (EAN)
EPDM EPDM	schwarz black		50 m	1 ME	Karton carton	4021036920397

Passend zu Serie | Compatible to series
GCW 050
GCW 060



Produktkennzeichen
Product identifier **750033**

Produktbezeichnung
Product designation **Dichtschnur**
Round cord

Artikelnummer
Item number **ZB750033**

Dichtschnur aus Moosgummi für diverse Anwendungen und Einsatzbereiche
Sealing cord made of foam rubber for various applications and areas of use

Werkstoff Material						Best.Nr. (EAN) Order No. (EAN)
EPDM EPDM	schwarz black		100 m	1 ME	Beutel bag	4021036527503

Passend zu Serie | Compatible to series
GCW 050
GCW 060

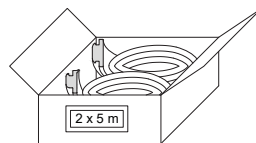

Produktkennzeichen
Product identifier **750046**

Produktbezeichnung
Product designation **Dichtset T-Stoß-S 050**
Sealing set T-Joint-S

Artikelnummer
Item number **E006228**

Dichtset für einen schräg einlaufenden Riegel
Sealing set for a diagonally incoming transom

Werkstoff Material						Best.Nr. (EAN) Order No. (EAN)
EPDM EPDM	schwarz black		1 Stück piece	1 ME	Karton carton	4021036483199

Passend zu Serie | Compatible to series
GCW 050

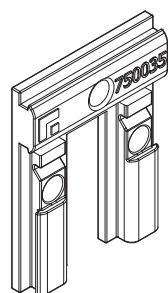

Produktkennzeichen
Product identifier **750035**

Produktbezeichnung
Product designation **Dichtstück**
Sealing piece

Artikelnummer
Item number **E006448**

Dichtstück zur Abdichtung im Stoßbereich Pfosten / Riegel
Sealing piece for sealing in the joint area mullion / transom

Werkstoff Material						Best.Nr. (EAN) Order No. (EAN)
EPDM EPDM	schwarz black		100 Stück 100 piece	1 ME	Beutel bag	4021036853169

Passend zu Serie | Compatible to series
GCW 050



Produktkennzeichen
Product identifier **750102**

Produktbezeichnung
Product designation **Verglasungsdichtung**
Glazing gasket

Artikelnummer
Item number **ZB750102**

Innere Verglasungsdichtung, Spaltbreite c = 2 mm, Füllstärken nach Glastabelle
Inner glazing gasket, gap width c = 2 mm, see glazing table for filling thickness

Werkstoff Material						Best.Nr. (EAN) Order No. (EAN)
EPDM EPDM	schwarz black		100 m	1 ME	Karton carton	4021036838494

Passend zu Serie | Compatible to series
GCW 050
GCW 060

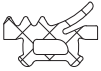

Produktkennzeichen
Product identifier
750203

Produktbezeichnung
Product designation
Verglasungsdichtung innen
Inner glazing gasket

Artikelnummer
Item number
ZB750203

Innere Verglasungsdichtung, Spaltbreite c = 3 mm, Füllstärken nach Glastabelle
Inner glazing gasket, gap width c = 3 mm, see glazing table for filling thickness

Werkstoff Material						Best.Nr. (EAN) Order No. (EAN)
EPDM EPDM	schwarz black		200 m	1 ME	Karton carton	4021036920526

Passend zu Serie | Compatible to series
GCW 050
GCW 060



Produktkennzeichen
Product identifier
750209

Produktbezeichnung
Product designation
Verglasungsdichtung
Glazing gasket

Artikelnummer
Item number
ZB750209

Innere Verglasungsdichtung, Spaltbreite c = 9 mm, Füllstärken nach Glastabelle
Inner glazing gasket, gap width c = 9 mm, see glazing table for filling thickness

Werkstoff Material						Best.Nr. (EAN) Order No. (EAN)
EPDM EPDM	schwarz black		50 m	1 ME	Karton carton	4021036920564

Passend zu Serie | Compatible to series
GCW 050
GCW 060

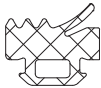

Produktkennzeichen
Product identifier
750205

Produktbezeichnung
Product designation
Verglasungsdichtung
Glazing gasket

Artikelnummer
Item number
ZB750205

Innere Verglasungsdichtung, Spaltbreite c = 5 mm, Füllstärken nach Glastabelle
Inner glazing gasket, gap width c = 5 mm, see glazing table for filling thickness

Werkstoff Material						Best.Nr. (EAN) Order No. (EAN)
EPDM EPDM	schwarz black		100 m	1 ME	Karton carton	4021036920533

Passend zu Serie | Compatible to series
GCW 050
GCW 060



Produktkennzeichen
Product identifier
750211

Produktbezeichnung
Product designation
Verglasungsdichtung
Glazing gasket

Artikelnummer
Item number
ZB750211

Innere Verglasungsdichtung, Spaltbreite c = 11 mm, Füllstärken nach Glastabelle
Inner glazing gasket, gap width c = 11 mm, see glazing table for filling thickness

Werkstoff Material						Best.Nr. (EAN) Order No. (EAN)
EPDM EPDM	schwarz black		50 m	1 ME	Karton carton	4021036920588

Passend zu Serie | Compatible to series
GCW 050
GCW 060

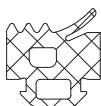

Produktkennzeichen
Product identifier
750207

Produktbezeichnung
Product designation
Verglasungsdichtung
Glazing gasket

Artikelnummer
Item number
ZB750207

Innere Verglasungsdichtung, Spaltbreite c = 7 mm, Füllstärken nach Glastabelle
Inner glazing gasket, gap width c = 7 mm, see glazing table for filling thickness

Werkstoff Material						Best.Nr. (EAN) Order No. (EAN)
EPDM EPDM	schwarz black		100 m	1 ME	Karton carton	4021036920540

Passend zu Serie | Compatible to series
GCW 050
GCW 060

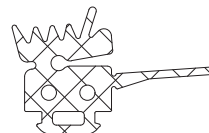

Produktkennzeichen
Product identifier
750301

Produktbezeichnung
Product designation
Verglasungsdichtung Außenecke
Glazing gasket for outer corner

Artikelnummer
Item number
ZB750301

Innere Pfostendichtung für Polygonfassade, Einsatzbereich 0 - 10° Außenecke, Füllstärke nach Glastabellen
Inner mullion gasket, for polygon curtain walls, application range 0 - 10° outside corner, see glazing tables for filling thicknesses

Werkstoff Material						Best.Nr. (EAN) Order No. (EAN)
EPDM EPDM	schwarz black		100 m	1 ME	Karton carton	4021036921080

Passend zu Serie | Compatible to series
GCW 050
GCW 060

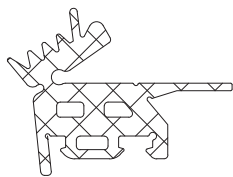

Produktkennzeichen
Product identifier

750311

Produktbezeichnung
Product designation





Verglasungsdichtung Außenecke
Glazing gasket for outer corner

Artikelnummer
Item number

ZB750311

Innere Pfostendichtung für Polygonfassade, Einsatzbereich 10 - 45° Außenecke, Füllstärke nach Glastabellen

Inner mullion gasket, for polygon curtain walls, application range 10 - 45° outside corner, see glazing tables for filling thicknesses

Werkstoff Material						Best.Nr. (EAN) Order No. (EAN)
EPDM EPDM	schwarz black		50 m	1 ME	Karton carton	4021036921103

Passend zu Serie | Compatible to series

GCW 050
GCW 060

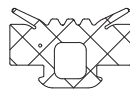

Produktkennzeichen
Product identifier

760006

Produktbezeichnung
Product designation

Verglasungsdichtung
Glazing gasket

Artikelnummer
Item number

E005265

Werkstoff Material						Best.Nr. (EAN) Order No. (EAN)
EPDM EPDM	schwarz black		100 m	1 ME	Karton carton	4021036866091

Passend zu Serie | Compatible to series

GCW 050
GCW 060

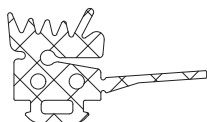

Produktkennzeichen
Product identifier

750331

Produktbezeichnung
Product designation



Verglasungsdichtung Innenecke
Glazing gasket inner corner

Artikelnummer
Item number

ZB750331

Innere Pfostendichtung für Polygonfassade, Einsatzbereich 0 - 10° Innenecke, Füllstärke nach Glastabellen

Inner mullion gasket, for polygon curtain walls, application range 0 - 10° inside corner, see glazing tables for filling thicknesses

Werkstoff Material						Best.Nr. (EAN) Order No. (EAN)
EPDM EPDM	schwarz black		100 m	1 ME	Karton carton	4021036921172

Passend zu Serie | Compatible to series

GCW 050
GCW 060

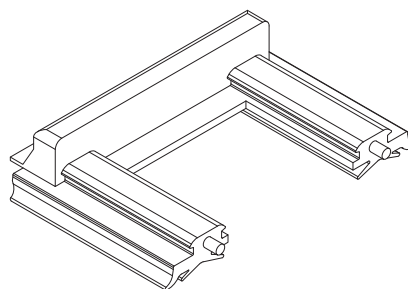

Produktkennzeichen
Product identifier

760024

Produktbezeichnung
Product designation

Druckleistendichtteil
Pressure strip sealing piece

Artikelnummer
Item number

ZB760024

Anschlussformteil für Druckleiste 159310 und Dichtung 750004, Spaltbreite c = 4 mm

Molded connection part for pressure strip 159310 and gasket 750004, gap width c = 4 mm

Werkstoff Material						Best.Nr. (EAN) Order No. (EAN)
EPDM EPDM	schwarz black		20 Stück piece	1 ME	Beutel bag	4021036526032

Passend zu Serie | Compatible to series

GCW 060



Produktkennzeichen
Product identifier

750402

Produktbezeichnung
Product designation

Verglasungsdichtung außen
Glazing gasket outside

Artikelnummer
Item number

ZB750402

Für Dachverglasung im Riegelbereich, Spaltbreite c = 2 mm

External glazing gasket for roof glazing around transoms, gap size c = 2 mm

Werkstoff Material						Best.Nr. (EAN) Order No. (EAN)
EPDM EPDM	schwarz black		50 m	1 ME	Karton carton	4021036921134

Passend zu Serie | Compatible to series

GCW 050
GCW 060

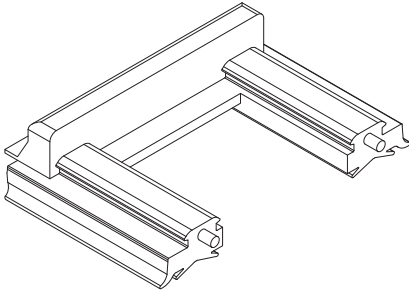

Produktkennzeichen
Product identifier **760026**
Produktbezeichnung
Product designation **Druckleistendichtteil**
Pressure strip sealing piece
Artikelnummer
Item number **ZB760026**

Anschlussformteil für Druckleiste 159310 und Dichtung 750006, Spaltbreite c = 6 mm
Molded connection part for pressure strip 159310 and gasket 750006, gap width c = 6 mm

Werkstoff Material						Best.Nr. (EAN) Order No. (EAN)
EPDM EPDM	schwarz black		20 Stück piece	1 ME	Beutel bag	4021036287896

Passend zu Serie | Compatible to series
GCW 060

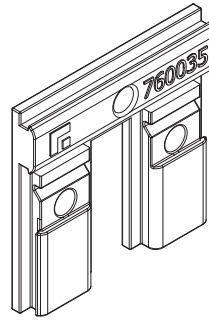

Produktkennzeichen
Product identifier **760035**
Produktbezeichnung
Product designation **Dichtstück**
Sealing piece
Artikelnummer
Item number **E006449**

Dichtstück zur Abdichtung im Stoßbereich Pfosten / Riegel
Sealing piece for sealing in the joint area mullion / transom

Werkstoff Material						Best.Nr. (EAN) Order No. (EAN)
EPDM EPDM	schwarz black		100 Stück 100 piece	1 ME	Beutel bag	4021036853268

Passend zu Serie | Compatible to series
GCW 060

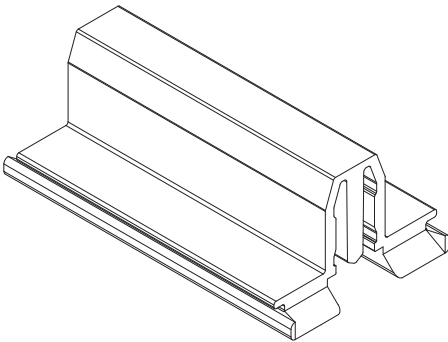

Produktkennzeichen
Product identifier **760030**
Produktbezeichnung
Product designation **Dehnungsstoßstück**
Expansion joint part
Artikelnummer
Item number **ZB760030**

Einsatz in Pfosten bei Dehnungsstößen
Application in mullions expansion joints

Werkstoff Material						Best.Nr. (EAN) Order No. (EAN)
EPDM EPDM	schwarz black		10 Stück piece	1 ME	Beutel bag	4021036921424

Passend zu Serie | Compatible to series
GCW 060

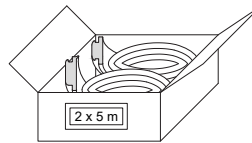

Produktkennzeichen
Product identifier **760046**
Produktbezeichnung
Product designation **Dichtset T-Stoß-S 060**
Sealing set T-Joint-S 060
Artikelnummer
Item number **E006229**

Dichtset für einen schräg einlaufenden Riegel
Sealing set for a diagonally incoming transom

Werkstoff Material						Best.Nr. (EAN) Order No. (EAN)
EPDM EPDM	schwarz black		1 Stück piece	1 ME	Karton carton	4021036483359

Passend zu Serie | Compatible to series
GCW 060



Produktkennzeichen
Product identifier **760104**
Produktbezeichnung
Product designation **Verglasungsdichtung**
Glazing gasket
Artikelnummer
Item number **E005444**

Innere Verglasungsdichtung, Spaltbreite c = 4 mm, Füllstärken nach Glastabelle
Inner glazing gasket, gap width c = 4 mm, see glazing table for filling thickness

Werkstoff Material						Best.Nr. (EAN) Order No. (EAN)
EPDM EPDM	schwarz black		100 m	1 ME	Karton carton	4021036931430

Passend zu Serie | Compatible to series
GCW 050
GCW 060

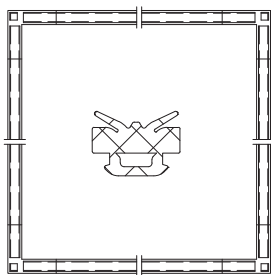

Produktkennzeichen
Product identifier
760104 99

Produktbezeichnung
Product designation
Dichtungsrahmen
Gasket frame

Artikelnummer
Item number
E005593

Rahmen aus Dichtung 760104
Frame made of gasket 760104

Werkstoff Material						Best.Nr. (EAN) Order No. (EAN)
EPDM EPDM	schwarz black		1 Stück piece	1 ME	Karton carton	4021036983804

Passend zu Serie | Compatible to series
GCW 050
GCW 060

Nur auf Anfrage! | Upon request!



Produktkennzeichen
Product identifier
760106

Produktbezeichnung
Product designation
Verglasungsdichtung
Glazing gasket

Artikelnummer
Item number
E005445

Innere Verglasungsdichtung, Spaltbreite
c = 6 mm, Füllstärken nach Glastabelle
Inner glazing gasket, gap width c = 6 mm, see glazing
table for filling thickness

Werkstoff Material						Best.Nr. (EAN) Order No. (EAN)
EPDM EPDM	schwarz black		100 m	1 ME	Karton carton	4021036931461

Passend zu Serie | Compatible to series
GCW 050
GCW 060

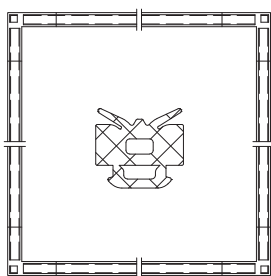

Produktkennzeichen
Product identifier
760106 99

Produktbezeichnung
Product designation
Dichtungsrahmen
Gasket frame

Artikelnummer
Item number
E005592

Rahmen aus Dichtung 760106
Frame made of gasket 760106

Werkstoff Material						Best.Nr. (EAN) Order No. (EAN)
EPDM EPDM	schwarz black		1 Stück piece	1 ME	Karton carton	4021036983798

Passend zu Serie | Compatible to series
GCW 050
GCW 060

Nur auf Anfrage! | Upon request!

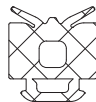

Produktkennzeichen
Product identifier
760108

Produktbezeichnung
Product designation
Verglasungsdichtung
Glazing gasket

Artikelnummer
Item number
E005446

Innere Verglasungsdichtung, Spaltbreite
c = 8 mm, Füllstärken nach Glastabelle
Inner glazing gasket, gap width c = 8 mm, see glazing
table for filling thickness

Werkstoff Material						Best.Nr. (EAN) Order No. (EAN)
EPDM EPDM	schwarz black		100 m	1 ME	Karton carton	4021036931645

Passend zu Serie | Compatible to series
GCW 050
GCW 060

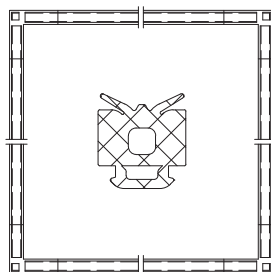

Produktkennzeichen
Product identifier
760108 99

Produktbezeichnung
Product designation
Dichtungsrahmen
Gasket frame

Artikelnummer
Item number
E005594

Rahmen aus Dichtung 760108
Frame made of gasket 760108

Werkstoff Material						Best.Nr. (EAN) Order No. (EAN)
EPDM EPDM	schwarz black		1 Stück piece	1 ME	Karton carton	4021036983811

Passend zu Serie | Compatible to series
GCW 050
GCW 060

Nur auf Anfrage! | Upon request!

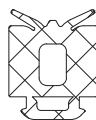

Produktkennzeichen
Product identifier
760110

Produktbezeichnung
Product designation
Verglasungsdichtung
Glazing gasket

Artikelnummer
Item number
E005263

Innere Verglasungsdichtung, Spaltbreite
c = 10 mm, Füllstärken nach Glastabelle
Inner glazing gasket, gap width c = 10 mm,
see glazing table for filling thickness

Werkstoff Material						Best.Nr. (EAN) Order No. (EAN)
EPDM EPDM	schwarz black		100 m	1 ME	Karton carton	4021036866077

Passend zu Serie | Compatible to series
GCW 050
GCW 060

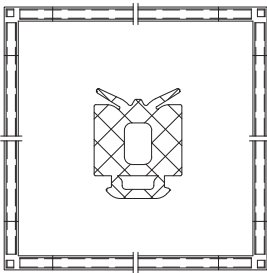

Produktkennzeichen
Product identifier **760110 99**

Produktbezeichnung
Product designation **Dichtungsrahmen**
Gasket frame

Artikelnummer
Item number **E005454**

Rahmen aus Dichtung 760110 **Frame made of gasket 760110**

Werkstoff Material						Best.Nr. (EAN) Order No. (EAN)
EPDM EPDM	schwarz black		1 Stück piece	1 ME	Karton carton	4021036891994

Passend zu Serie | Compatible to series
GCW 050
GCW 060

Nur auf Anfrage! | Upon request!



Produktkennzeichen
Product identifier **760112**

Produktbezeichnung
Product designation **Verglasungsdichtung**
Glazing gasket

Artikelnummer
Item number **E005447**

Innere Verglasungsdichtung, Spaltbreite
c = 12 mm, Füllstärken nach Glastabelle **Inner glazing gasket, gap width c = 12 mm, see glazing
table for filling thickness**

Werkstoff Material						Best.Nr. (EAN) Order No. (EAN)
EPDM EPDM	schwarz black		100 m	1 ME	Karton carton	4021036931676

Passend zu Serie | Compatible to series
GCW 050
GCW 060

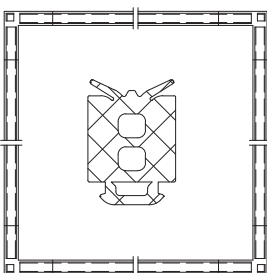

Produktkennzeichen
Product identifier **760112 99**

Produktbezeichnung
Product designation **Dichtungsrahmen**
Gasket frame

Artikelnummer
Item number **E005591**

Rahmen aus Dichtung 760112 **Frame made of gasket 760112**

Werkstoff Material						Best.Nr. (EAN) Order No. (EAN)
EPDM EPDM	schwarz black		1 Stück piece	1 ME	Karton carton	4021036983781

Passend zu Serie | Compatible to series
GCW 050
GCW 060

Nur auf Anfrage! | Upon request!



Produktkennzeichen
Product identifier **760114**

Produktbezeichnung
Product designation **Verglasungsdichtung**
Glazing gasket

Artikelnummer
Item number **E005448**

Innere Verglasungsdichtung, Spaltbreite
c = 14 mm, Füllstärken nach Glastabelle **Inner glazing gasket, gap width c = 14 mm, see glazing
table for filling thickness**

Werkstoff Material						Best.Nr. (EAN) Order No. (EAN)
EPDM EPDM	schwarz black		50 m	1 ME	Karton carton	4021036931683

Passend zu Serie | Compatible to series
GCW 050
GCW 060

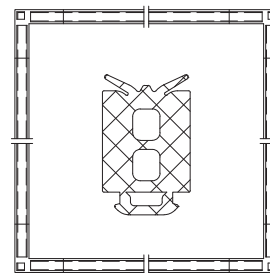

Produktkennzeichen
Product identifier **760114 99**

Produktbezeichnung
Product designation **Dichtungsrahmen**
Gasket frame

Artikelnummer
Item number **E005595**

Rahmen aus Dichtung 760114 **Frame made of gasket 760114**

Werkstoff Material						Best.Nr. (EAN) Order No. (EAN)
EPDM EPDM	schwarz black		1 Stück piece	1 ME	Karton carton	4021036983828

Passend zu Serie | Compatible to series
GCW 050
GCW 060

Nur auf Anfrage! | Upon request!

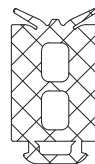

Produktkennzeichen
Product identifier **760116**

Produktbezeichnung
Product designation **Verglasungsdichtung**
Glazing gasket

Artikelnummer
Item number **E005449**

Innere Verglasungsdichtung, Spaltbreite
c = 16 mm, Füllstärken nach Glastabelle **Inner glazing gasket, gap width c = 16 mm, see glazing
table for filling thickness**

Werkstoff Material						Best.Nr. (EAN) Order No. (EAN)
EPDM EPDM	schwarz black		50 m	1 ME	Karton carton	4021036931843

Passend zu Serie | Compatible to series
GCW 050
GCW 060

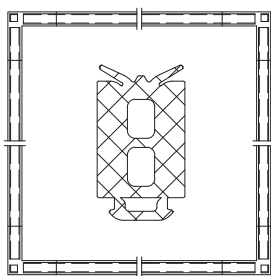



Produktkennzeichen
Product identifier 760116 99

Produktbezeichnung
Product designation Dichtungsrahmen
Gasket frame

Artikelnummer
Item number E005596

Rahmen aus Dichtung 760116
Frame made of gasket 760116

Werkstoff Material						Best.Nr. (EAN) Order No. (EAN)
EPDM EPDM	schwarz black		1 Stück	1 ME	Karton carton	4021036983835

Passend zu Serie | Compatible to series

GCW 050
GCW 060

Nur auf Anfrage! | Upon request!







Produktkennzeichen
Product identifier 770009

Produktbezeichnung
Product designation Verglasungsdichtung außen
Outer glazing gasket

Artikelnummer
Item number ZB770009

Spaltbreite c = 2 mm
Gap width c = 1,5 mm

Werkstoff Material						Best.Nr. (EAN) Order No. (EAN)
Silikon Silicone	schwarz black		50 m	1 ME	Karton carton	4021036921929

Passend zu Serie | Compatible to series

GCW 050
GCW 060







Produktkennzeichen
Product identifier 770010

Produktbezeichnung
Product designation Verglasungsdichtung außen
Glazing gasket outside

Artikelnummer
Item number ZB770010

Spaltbreite c = 3,5 mm
Gap width c = 3,5 mm

Werkstoff Material						Best.Nr. (EAN) Order No. (EAN)
Silikon Silicone	schwarz black		50 m	1 ME	Karton carton	4021036921936

Passend zu Serie | Compatible to series

GCW 050
GCW 060

BESTELLFORMULAR | ORDER FORM:

Dichtungsrahmen 760104 99 aus Dichtung 760104

Gasket frame 760104 99 made of gasket 760104

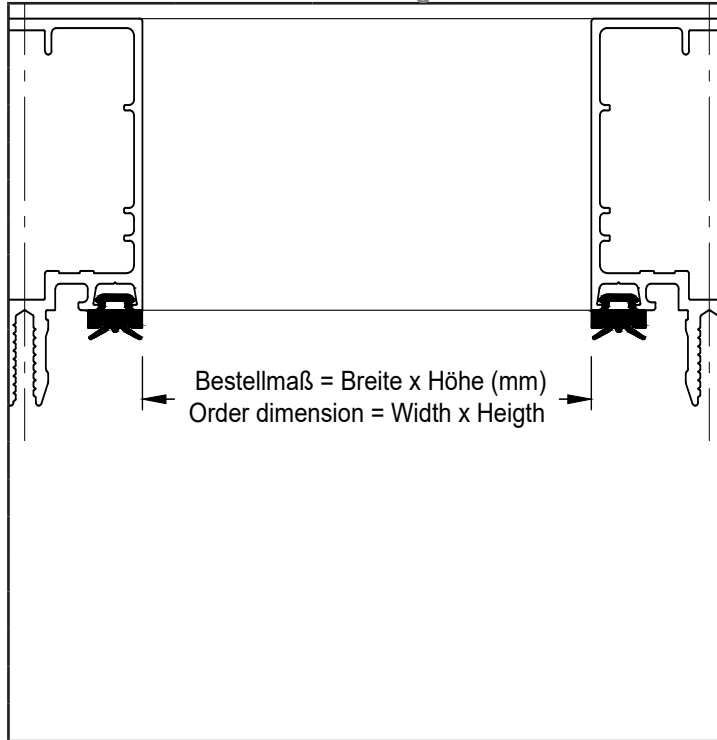

- PREISANFRAGE | PRICE INQUIRY
 BESTELLUNG | ORDER

Position Position	Stück Quantity	Breite (mm) Width (mm)	Höhe (mm) Height (mm)

Objekt Nr. Object no.	Objektbezeichnung Object description

Gewünschter Liefertermin (TT.MM.JJJJ) Desired delivery date (DD.MM.YYYY)

Lieferadresse: Delivery address:	Land Country	PLZ Post code	ORT City	Straße Street	Nr. No.

Kunden-Nr.: Customer no:	Kundenname: Customer name:	Ansprechpartner: Contact person:	Telefon / Durchwahl: Telephone / extension:	em@il



GUTMANN Bausysteme GmbH
Nürnberger Straße 57
D-91781 Weißenburg i. Bay.

FAX: +49 (9141) 992 - 620
TEL: +49 (9141) 992 - 0



BESTELLFORMULAR | ORDER FORM:
Dichtungsrahmen 760106 99 aus Dichtung 760106
Gasket frame 760106 99 made of gasket 760106

- PREISANFRAGE | PRICE INQUIRY
- BESTELLUNG | ORDER

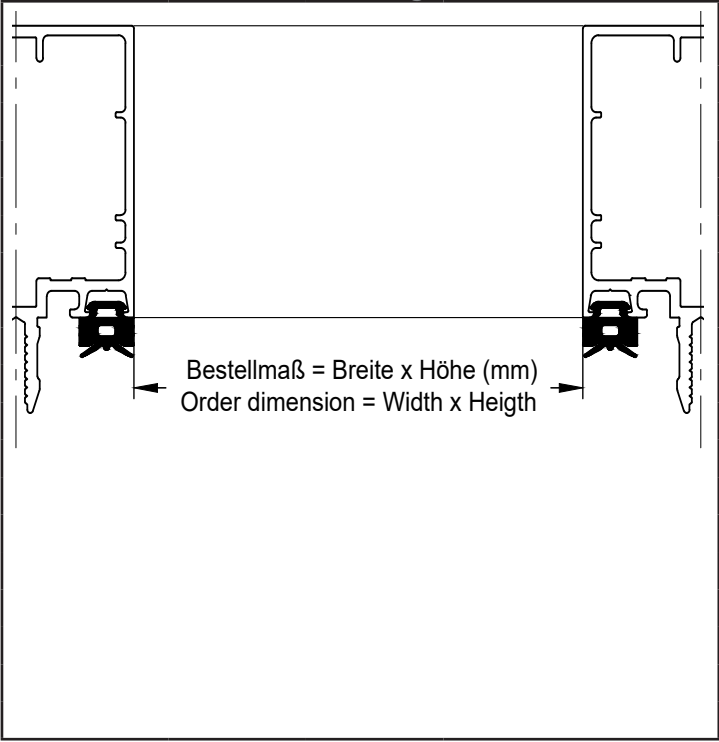

Position Position	Stück Quantity	Breite (mm) Width (mm)	Höhe (mm) Height (mm)

Objekt Nr. Object no.	Objektbezeichnung Object description

Gewünschter Liefertermin (TT.MM.JJJJ) Desired delivery date (DD.MM.YYYY)

Lieferadresse: Delivery address:	Land Country	PLZ Post code	ORT City	Straße Street	Nr. No.

Kunden-Nr.: Customer no:	Kundenname: Customer name:	Ansprechpartner: Contact person:	Telefon / Durchwahl: Telephone / extension:	em@il



GUTMANN Bausysteme GmbH
 Nürnberger Straße 57
 D-91781 Weißenburg i. Bay.

FAX: +49 (9141) 992 - 620
 TEL: +49 (9141) 992 - 0

BESTELLFORMULAR | ORDER FORM:
Dichtungsrahmen 760108 99 aus Dichtung 760108
Gasket frame 760108 99 made of gasket 760108

PREISANFRAGE | PRICE INQUIRY
 BESTELLUNG | ORDER

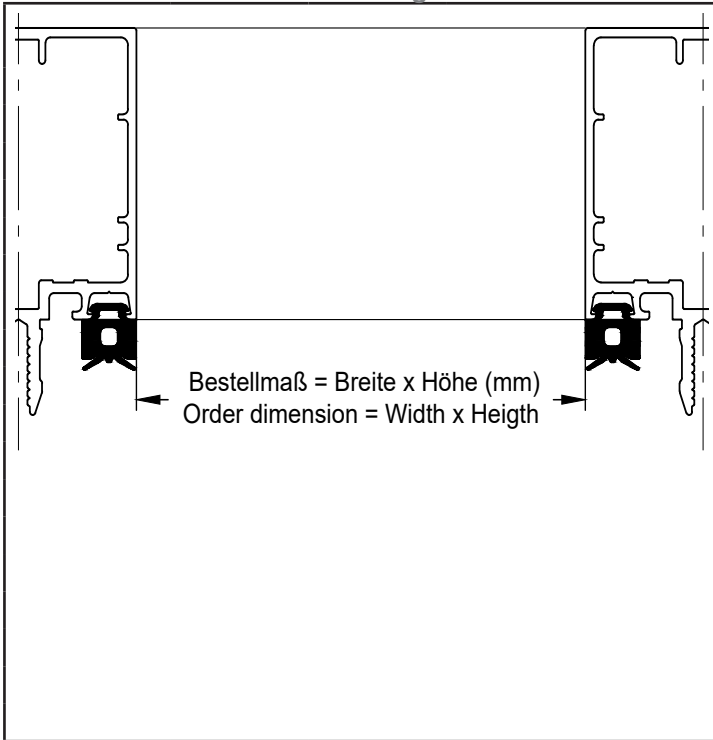

Position Position	Stück Quantity	Breite (mm) Width (mm)	Höhe (mm) Height (mm)

Objekt Nr. Object no.	Objektbezeichnung Object description

Gewünschter Liefertermin (TT.MM.JJJJ) Desired delivery date (DD.MM.YYYY)

Lieferadresse: Delivery address:	Land Country	PLZ Post code	ORT City	Straße Street	Nr. No.

Kunden-Nr.: Customer no:	Kundenname: Customer name:	Ansprechpartner: Contact person:	Telefon / Durchwahl: Telephone / extension:	em@il



GUTMANN Bausysteme GmbH
Nürnberger Straße 57
D-91781 Weißenburg i. Bay.

FAX: +49 (9141) 992 - 620
TEL: +49 (9141) 992 - 0



BESTELLFORMULAR | ORDER FORM:

Dichtungsrahmen 760110 99 aus Dichtung 760110
Gasket frame 760110 99 made of gasket 760110

- PREISANFRAGE | PRICE INQUIRY
- BESTELLUNG | ORDER

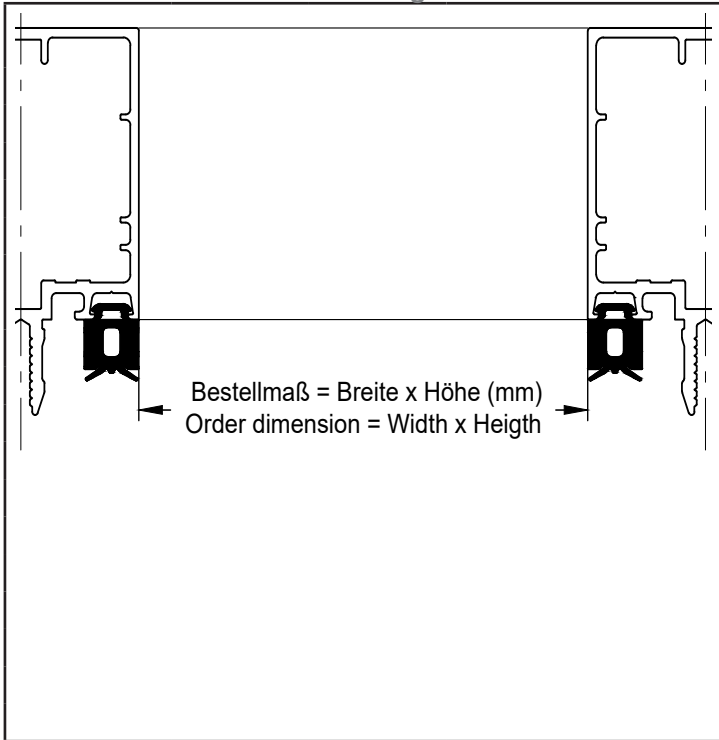

Position Position	Stück Quantity	Breite (mm) Width (mm)	Höhe (mm) Height (mm)

Objekt Nr. Object no.	Objektbezeichnung Object description

Gewünschter Liefertermin (TT.MM.JJJJ) Desired delivery date (DD.MM.YYYY)

Lieferadresse: Delivery address:	Land Country	PLZ Post code	ORT City	Straße Street	Nr. No.

Kunden-Nr.: Customer no:	Kundenname: Customer name:	Ansprechpartner: Contact person:	Telefon / Durchwahl: Telephone / extension:	em@il



GUTMANN

GUTMANN Bausysteme GmbH
Nürnberger Straße 57
D-91781 Weißenburg i. Bay.

FAX: +49 (9141) 992 - 620
TEL: +49 (9141) 992 - 0



BESTELLFORMULAR | ORDER FORM:
Dichtungsrahmen 760112 99 aus Dichtung 760112
Gasket frame 760112 99 made of gasket 760112

- PREISANFRAGE | PRICE INQUIRY
 BESTELLUNG | ORDER

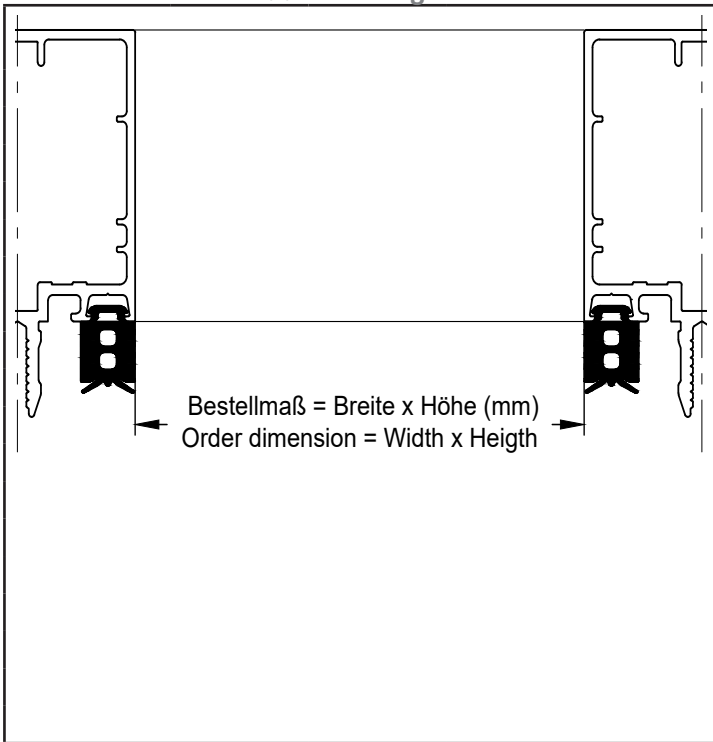

Position Position	Stück Quantity	Breite (mm) Width (mm)	Höhe (mm) Height (mm)

Objekt Nr. Object no.	Objektbezeichnung Object description

Gewünschter Liefertermin (TT.MM.JJJJ) Desired delivery date (DD.MM.YYYY)

Lieferadresse: Delivery address:	Land Country	PLZ Post code	ORT City	Straße Street	Nr. No.

Kunden-Nr.: Customer no:	Kundenname: Customer name:	Ansprechpartner: Contact person:	Telefon / Durchwahl: Telephone / extension:	em@il



GUTMANN Bausysteme GmbH
Nürnberger Straße 57
D-91781 Weißenburg i. Bay.

FAX: +49 (9141) 992 - 620
TEL: +49 (9141) 992 - 0

G U T M A N N

BESTELLFORMULAR | ORDER FORM:
Dichtungsrahmen 760116 99 aus Dichtung 760116
Gasket frame 760116 99 made of gasket 760116

- PREISANFRAGE | PRICE INQUIRY
 BESTELLUNG | ORDER

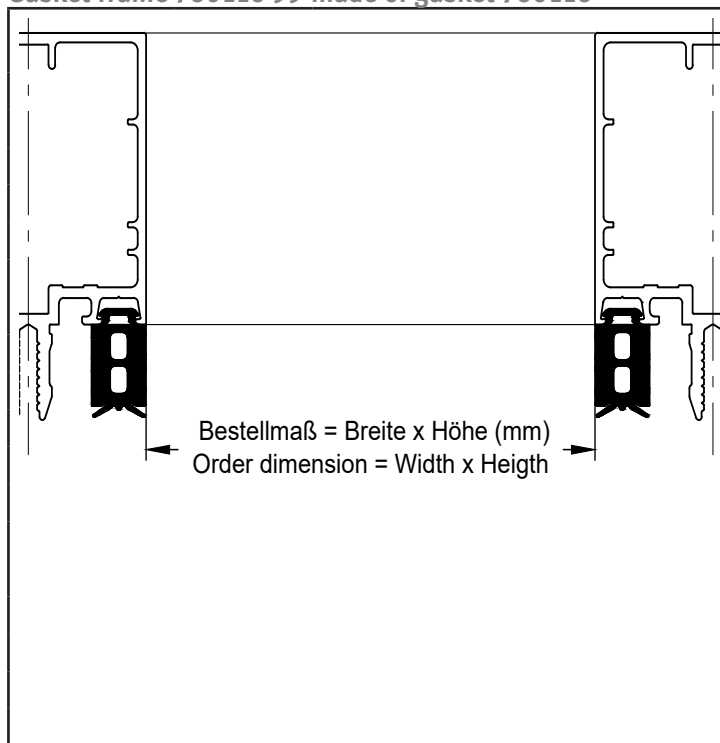

Position Position	Stück Quantity	Breite (mm) Width (mm)	Höhe (mm) Height (mm)

Objekt Nr. Object no.	Objektbezeichnung Object description

Gewünschter Liefertermin (TT.MM.JJJJ) Desired delivery date (DD.MM.YYYY)

Lieferadresse: Delivery address:	Land Country	PLZ Post code	ORT City	Straße Street	Nr. No.

Kunden-Nr.: Customer no:	Kundenname: Customer name:	Ansprechpartner: Contact person:	Telefon / Durchwahl: Telephone / extension:	em@il

GUTMANN Bausysteme GmbH
Nürnberger Straße 57
D-91781 Weißenburg i. Bay.
FAX: +49 (9141) 992 - 620
TEL: +49 (9141) 992 - 0

